

# VIDEOBADGE VB-400

The VideoBadge VB-400 Body-worn Camera is designed for 21st century public safety and security.



## GENERAL INFORMATION

	The VB-400 is suited to applications where shift-long battery life and high-quality video evidence capture is required..
Typical Usage	The VB-400 represents the next generation of body-worn camera technology. Rugged build quality. High performance. Multiple ways to connect. Delivering the features you need to take control of every situation.
Management Software	VideoManager 12.1 or later. Requires VideoManager Licence or Cloud Service.

## SIZE AND WEIGHT

Dimensions	68mm x 89mm x 25mm
Weight	160g, plus mounting

## BATTERY

Battery	Integral, not user serviceable.
Battery Type	Lithium-Polymer
Battery Recharging Times	Typically recharges in less than 8 hours.
Capacity	Up to 12-hrs when used with optimum camera settings*.

## AUDIO

Audio Capture	Dual Microphone.
---------------	------------------

## CAMERA

Switches	Five software-configurable switches (top switch, two small front switches and large central switch) and a slide switch (side mounted).
Lens Capture Angle	120° horizontal, 65° vertical, 140° diagonal
Day / Night Operation	Supports low light conditions to 0.2 lux.
Notification:	Configurable LEDs, audible and vibration alerts and notifications.

## CAMERA FEATURES

Peer-assisted Recording	Device recording can commence securely when within 10m of another device that is already recording.
Holster Sensor Option	Detect the presence of a firearm, and notify the VB-400 when it's unholstered.
Pre / Post-Record Facility	Full-shift pre / post-record, with up to 2 minute pre / post-recording buffer.
RFID Assignment	Use RFID to allocate cameras to users.
Bookmark Footage	Instantly mark important video footage by pressing a configured switch or button.
Recording Status User Notification	Vibration, visual and audible notification.
GPS	Integral GPS receiver. Mark video streams and recordings with location, and provide location data to management software.
Bluetooth®	BT 2.1 + EDR, BLE 4.2

\*Features such as Wi-Fi impact battery life.

**VIDEO AND RECORDING**

Video Recording Format	H.264 format with H.265 in future release.
Resolution	1920x1080p, 1280x720p and 640x360p
Frame Rate	25 or 30 frames per second.
Recording Storage Capacity	64GB

**APPROVALS AND ENVIRONMENTAL**

Ingress Protection	IP67
Environmental Temperature	Operating: -20°C to +50°C
Operational Rating	Charging: 0°C to +25°C
Drop Tested	Tested to MIL STD 810G.

**WI-FI FEATURES**

Wi-Fi Specifications	802.11 a/b/g/n (2.4GHz & 5GHz)
Wi-Fi Security	WPA2-PSK
Wi-Fi Streaming	640x360 25 or 30 fps

**SECURITY**

Network Data Security on USB Storage Media	VideoBadge does not appear as a USB storage device, and cannot receive files whilst connected to a Wi-Fi network.
Digital Evidence Integrity Chain	Full audit trail with generated check-sums and watermarked evidential outputs.
Audit Trail	Usage, operations and recording details all audit-logged and indexed.
Video Downloading Protected by Encryption	AES 256, encrypted keys specific to base station.
Recordings View, Copy and Deletion Ability	The VideoBadge wearer cannot access, view or delete any recordings directly from the device, or VideoManager without appropriate authorisation.
Storage Media Access	Sealed unit with no user access to storage media.

**View on Front Face**

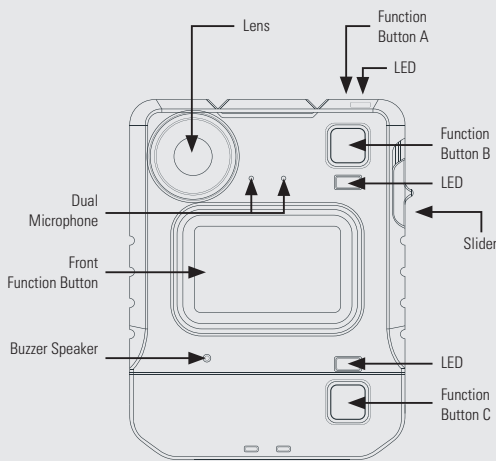

**View on Back Face**

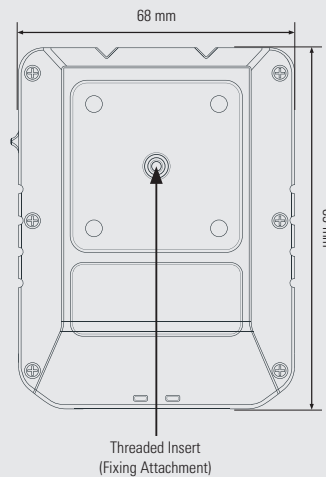

**View on Right Face**

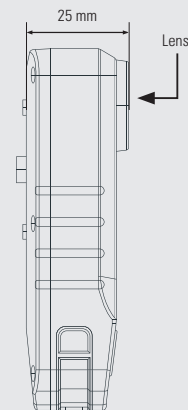

**View on Left Face**

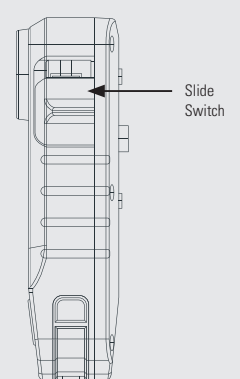

**View on Top Face**

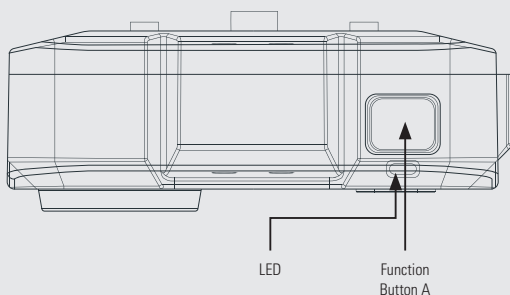

**View on Bottom Face**

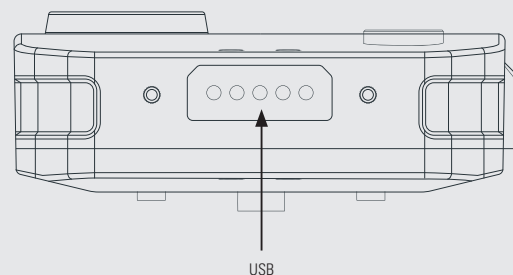

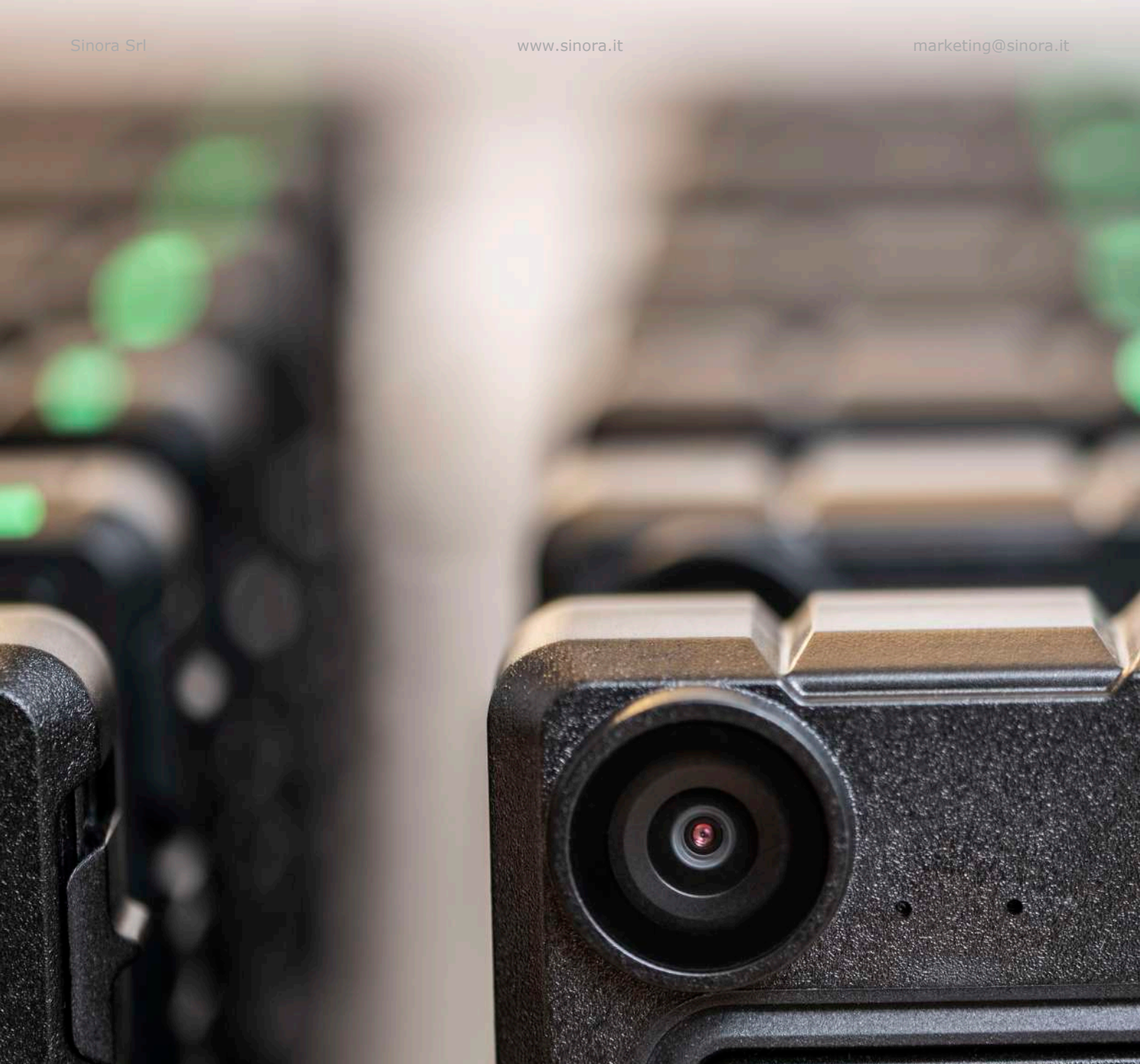

# VIDEOBADGE VB-400

**ACCESSORIES**

# VIDEOBADGE VB-440-64-QR-N & ACCESSORIES

## VIDEOBADGE VB-400 (VB-440-64-QR-N) - SUITABLE FOR ATTACHING TO THE QUICK RELEASE FIXING OPTIONS



**Features include:**

Wi-Fi streaming, Built-in GPS functionality, Bluetooth® sensor monitoring, Ruggedised exterior, 64GB storage, Slimline battery (up to 12hrs recording time), 1 year return-to-base warranty.

PLEASE NOTE: Requires VideoManager Enterprise Licence or VideoManager Cloud Service. Please speak to your account manager for further details.

**PART NUMBER:** VB-440-64-QR-N



## CHARGERS, DOCKCONTROLLERS, RFIDS & CUSTOM DISPLAY STICKERS

VB-400-DOCK-SOLO	VideoBadge VB-400 1-Port Dock
VB-400-DOCK-14/UK, VB-400-DOCK-14/EU, VB-400-DOCK-14/US, VB-400-DOCK-14/AUS, VB-400-DOCK-14/ROW	VideoBadge VB-400 14-Port Dock
DC-200/UK, DC-200/EU, DC-200/US, DC-200/AUS, DC-200/ROW	DockController DC-200
RF-220	RFID RF-220
RF-STICKER-10	RFID Sticker-Style Tag
RF-CARD-10	RFID-Card
VB-400-ID-CUS-ART	Custom VB-400 Front-button Sticker (Design)
VB-400-ID-CUS-100, VB-400-ID-CUS-250, VB-400-ID-CUS-1000, VB-400-ID-CUS-5000	Custom VB-400 Front-button Sticker (Print) Can be ordered in the following amounts: 100, 250, 1000, 5000



## QUICK RELEASE FIXINGS

VB-400-QR-KFSTUD	Klick Fast Quick Release Stud
VB-400-QR-KFTILT	Klick Fast Quick Release Tilt Mount
VB-400-QR-KFTILT2	Klick Fast Quick Release Wide Tilt Mount
VB-400-QR-SPORT	Quick Release Sports Camera Pillar



## KLICK FAST HARNESSES

Klick Fast Harnesses are compatible with the **VB-440-64-QR-N** when used in conjunction with Klick Fast Quick Release Fixings. Also available for the **VB-440-64-KF-N** camera.

KF-HARN3	Klick Fast 3-Point Chest Harness
KF-HARN4	Klick Fast 4-Point Chest Harness
KF-HARN5	Klick Fast Shoulder Harness



# VIDEOBADGE VB-440-64-KF-N & ACCESSORIES

## VIDEOBADGE VB-400 (VB-440-64-QR-N) - SUITABLE FOR DIRECTLY ATTACHING TO THE KLICK FAST FIXING OPTIONS



**Features include:**

Wi-Fi streaming, Built-in GPS functionality, Bluetooth® sensor monitoring, Ruggedised exterior, 64GB storage, Slimline battery (up to 12hrs recording time), 1 year return-to-base warranty.

PLEASE NOTE: Requires VideoManager Enterprise Licence or VideoManager Cloud Service. Please speak to your account manager for further details.

**PART NUMBER:** VB-440-64-KF-N



### CHARGERS, DOCKCONTROLLERS, RFIDS & CUSTOM DISPLAY STICKERS

Keep your cameras functioning at all times with these essentials.

VB-400-DOCK-SOLO	VideoBadge VB-400 1-Port Dock
VB-400-DOCK-14/UK, VB-400-DOCK-14/EU, VB-400-DOCK-14/US, VB-400-DOCK-14/AUS, VB-400-DOCK-14/ROW	VideoBadge VB-400 14-Port Dock
DC-200/UK, DC-200/EU, DC-200/US, DC-200/AUS, DC-200/ROW	DockController DC-200
RF-220	RFID RF-220
RF-STICKER-10	RFID Sticker-Style Tag (x10)
RF-CARD-10	RFID-Card (x10)
VB-400-ID-CUS-ART	Custom VB-400 Front-button Sticker (Design)
VB-400-ID-CUS-250, VB-400-ID-CUS-1000, VB-400-ID-CUS-5000	Custom VB-400 Front-button Sticker (Print) Can be ordered in the following amounts: 250, 1000, 5000



### KLICK FAST HARNESES

KF-HARN3	Klick Fast 3-Point Chest Harness
KF-HARN4	Klick Fast 4-Point Chest Harness
KF-HARN5	Klick Fast Shoulder Harness



### KLICK FAST FIXINGS

Also available for the **VB-440-64-QR-N** when used in conjunction with Klick Fast Quick Release Fixings.

KF-SCREW	Klick Fast Uniform Screw-on Dock
KF-LOOP	Klick Fast Radio Loop Dock
KF-DOCKCLAMP	Klick Fast Dock Clamp (Pocket Klick Fast Dock)
KF-DOCKEP	Klick Fast Dock Epaulette
KF-MAGMOUNT	Klick Fast Magnetic Mounting Set (Supplied w/o Magnets)
KF-MOLLEVEST	Klick Fast Dock for MOLLE Vests

# VIDEOBADGE VB-440-64-VF-N & ACCESSORIES

## VIDEOBADGE VB-400 (VB-440-64-QR-N) - SUITABLE FOR ATTACHING TO THE CLOSE FIT MOUNT OPTIONS



**Features include:**

Wi-Fi streaming, Built-in GPS functionality, Bluetooth® sensor monitoring, Ruggedised exterior, 64GB storage, Slimline battery (up to 12hrs recording time), 1 year return-to-base warranty.

PLEASE NOTE: Requires VideoManager Enterprise Licence or VideoManager Cloud Service. Please speak to your account manager for further details.

**PART NUMBER:** VB-440-64-VF-N



VB-400-DOCK-SOLO



VB-400-DOCK-14/UK etc.



DC-200/UK etc.



RF-220



VB-400-ID-CUS-ART



VB-400-ID-CUS-100 etc.

## CHARGERS, DOCKCONTROLLERS, RFIDS & CUSTOM DISPLAY STICKERS

Keep your cameras functioning at all times with these essentials.

VB-400-DOCK-SOLO	VideoBadge VB-400 1-Port Dock
VB-400-DOCK-14/UK, VB-400-DOCK-14/EU, VB-400-DOCK-14/US, VB-400-DOCK-14/AUS, VB-400-DOCK-14/ROW	VideoBadge VB-400 14-Port Dock
DC-200/UK, DC-200/EU, DC-200/US, DC-200/AUS, DC-200/ROW	DockController DC-200
RF-220	RFID RF-220
RF-STICKER-10	RFID Sticker-Style Tag (x10)
RF-CARD-10	RFID-Card (x10)
VB-400-ID-CUS-ART	Custom VB-400 Front-button Sticker (Design)
VB-400-ID-CUS-250, VB-400-ID-CUS-1000, VB-400-ID-CUS-5000	Custom VB-400 Front-button Sticker (Print) Can be ordered in the following amounts: 250, 1000, 5000



VB-400-VF-MAG



VB-400-VF-MOL2

## CLOSE-FIT MOUNTS

VB-400-VF-MAG	Close-Fit Magnetic Mount
VB-400-VF-MOL2	Close-Fit Double MOLLE Mount

# VIDEOBADGE VB-440-64-ALIG-N & ACCESSORIES

## VIDEOBADGE VB-400 (VB-440-64-QR-N) - COMES WITH A FACTORY FITTED ALLIGATOR CLIP



**Features include:**

Wi-Fi streaming, Built-in GPS functionality, Bluetooth® sensor monitoring, Ruggedised exterior, 64GB storage, Slimline battery (up to 12hrs recording time), 1 year return-to-base warranty.

PLEASE NOTE: Requires VideoManager Enterprise Licence or VideoManager Cloud Service. Please speak to your account manager for further details.

**PART NUMBER:** VB-440-64-ALIG-N



## CHARGERS, DOCKCONTROLLERS, RFIDS & CUSTOM DISPLAY STICKERS

Keep your cameras functioning at all times with these essentials.

VB-400-DOCK-SOLO	VideoBadge VB-400 1-Port Dock
VB-400-DOCK-14/UK, VB-400-DOCK-14/EU, VB-400-DOCK-14/US, VB-400-DOCK-14/AUS, VB-400-DOCK-14/ROW	VideoBadge VB-400 14-Port Dock
DC-200/UK, DC-200/EU, DC-200/US, DC-200/AUS, DC-200/ROW	DockController DC-200
RF-220	RFID RF-220
RF-STICKER-10	RFID Sticker-Style Tag (x10)
RF-CARD-10	RFID-Card (x10)
VB-400-ID-CUS-ART	Custom VB-400 Front-button Sticker (Design)
VB-400-ID-CUS-250, VB-400-ID-CUS-1000, VB-400-ID-CUS-5000	Custom VB-400 Front-button Sticker (Print) Can be ordered in the following amounts: 250, 1000, 5000





For more information, please visit: [www.motorolasolutions.com](http://www.motorolasolutions.com)

Motorola Solutions Ltd. Nova South, 160 Victoria Street, London, SW1E 5LB, United Kingdom

Availability is subject to individual country law and regulations. All specifications shown are typical unless otherwise stated and are subject to change without notice. MOTOROLA, MOTO, MOTOROLA SOLUTIONS and the Stylized M Logo are trademarks or registered trademarks of Motorola Trademark Holdings, LLC and are used under license. All other trademarks are the property of their respective owners.  
© 2020 Motorola Solutions, Inc. All rights reserved. (03/20) (ED-002-041-14)